

TECHNICAL DATA

U_{max}	1.9 V	$T_{hot}=25^{\circ}C$ Dry air
Q_{max}	10.3 W	
ΔT_{max}	68°	
I_{max}	8.6 A	
ACR at 25°C	0.2 Ohm	
Hot side	Ceramics Al_2O_3 , white 96%	
Cold side		
Max. processing temperature	Depends on chosen solder type	
Standard tolerances for thermal and electrical parameters $\pm 10\%$		

STANDARD ORDERING OPTIONS

Nº	Option	Parameter		
1	Lead wires	AWG Nº		
		18	20	22
2	Lead wires length	L - under customer request		
3	Lead wires insulation	Type / Max. processing temp.		
		Without insulation / See solder type m.p.t		
		PVC / 105° C		
		Silicone / 180° C		
4	Internal solder	Type / Max. processing temp.		
		Type-1 / 138° C		
		Type-2 / 227° C		
		Type-3 / 232° C		
5	Anticorrosional coating	yes	no	
6	Sealing	Type / Max. processing temp.		
		Without sealing / 200° C		
		Epoxy / 130° C		
		Silicone / 180° C		

MODULE DRAWING standard design

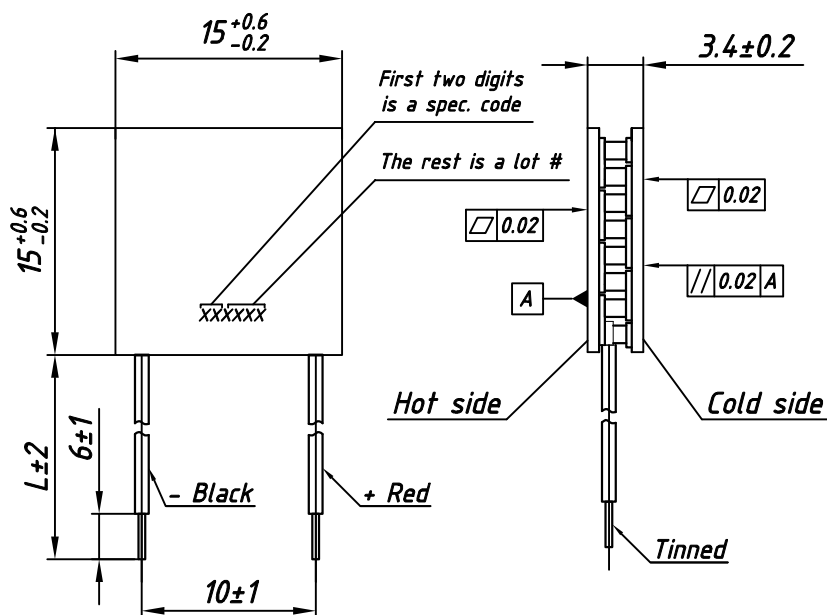

AVAILABLE MODIFICATIONS

Design	Description
TM-17-1.4-8.5 M	High reliable version on cold side

OPTIONS UPON REQUEST

Height tolerance	± 0.02
Unflatness and nonparallelism	± 0.02

- Solder type marked * is not compliant to RoHS (2002/95/EC)
- For another options consult of our technical support engineers